

TOSHIBA

INSTRUCTION MANUAL

3 CCD COLOR CAMERA

IK-TU40A

For Customer Use

Enter below the Serial No. which is located on the bottom of the cabinet. Retain this information for future reference.

Model No. :IK-TU40A

Serial No.:

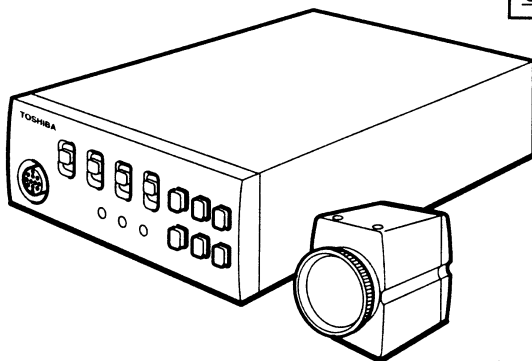

INFORMATION

This equipment has been tested and found to comply with the limits for a Class A digital device, pursuant to Part 15 of the FCC Rules. These limits are designed to provide reasonable protection against harmful interference when the equipment is operated in a commercial environment. This equipment generates, uses, and can radiate radio frequency energy and, if not installed and used in accordance with the instruction manual, may cause harmful interference to radio communications. Operation of this equipment in a residential area is likely to cause harmful interference in which case the user will be required to correct the interference at his own expense.

USER-INSTALLER CAUTION: Your authority to operate this FCC verified equipment could be voided if you make changes or modifications not expressly approved by the party responsible for compliance to Part 15 of the FCC rules.

This Class A digital apparatus meets all requirements of the Canadian Interference Causing Equipment Regulations.

Cet appareil numérique de la classe A respecte toutes les exigences du Règlement sur le matériel brouilleur du Canada.

TABLE OF CONTENTS

1. COMPONENTS	4
2. SPECIFICATIONS	4
3. ITEMS CONTROLLED BY USING ON SCREEN DISPLAY	5
4. NAMES AND FUNCTIONS	6
5. CONNECTION	8
5.1 Standard Connection	8
5.2 Cautions on Connection	8
5.3 Connection on Back Panel	9
6. OPERATION	10
6.1 Automatic Black Balance	10
6.2 White Balance	10
6.3 Scene File	12
6.4 Gain	12
6.5 Shading Correction	12
7. MODE SETTING BY ON SCREEN DISPLAY	14
7.1 Using the Menus	14
7.2 Menus	16
(1) SHUTTER (Electronic shutter)	16
(1.1) Changing each setting in AUTO mode	16
(1.2) Changing each setting in MANU mode	18
(1.3) Changing each setting in SS (syncro. scan) mode	18
(1.4) Changing each setting in 1 PULSE mode	19
(2) GAIN (Video gain)	19
(2.1) Changing the maximum gain in AUTO (Automatic gain control) mode	19
(2.2) MANU (manual) mode menu	20
(2.3) NORM (0 dB) mode menu	20
(3) WHT BAL (white balance)	20
(3.1) ATW (Automatic Trace White Balance) mode menu	20
(3.2) Changing the AWB (Automatic White Balance) mode setting ...	20
(3.3) MANU (manual) mode menu	21
(4) PROCESS (Process)	22
(4.1) Changing the gamma correction ON/OFF	22
(4.2) Changing gamma correction level	22
(4.3) Changing black gamma correction level	23
(4.4) Changing two-dimension low pass filter	23
(4.5) Changing detail (outline) gain	23
(4.6) Changing detail boost frequency	23
(4.7) Changing master pedestal	24

(5) SYNC (sync)	24
(5.1) INT screen	24
(5.2) Changing EXT setting	24
(6) OPTION	25
(6.1) Changing OUTPUT 1 output	25
(6.2) Changing OUTPUT 2 output	25
(6.3) Changing Negative/Positive inversion switch	25
(6.4) Changing detail signal output	25
(6.5) Changing shading	26
(6.6) Changing G SYNC	26
(7) Setting USER area	26
(8) Setting to factory setting status	27
7.3 External Sync	27
(1) External sync signal input conditions	27
(2) External sync frequency range	28
(3) Using the camera with external sync signal	28
(3.1) H (horizontal) phase adjustment	28
(3.2) SC (Sub carrier) phase adjustment	28
7.4 1 PULSE	28
7.5 Syncro. Scan Operation	29
(1) Setting by 1H	29
(2) Setting by the frame	29
8. CAUTIONS ON USE AND INSTALLATION	30
9. BEFORE MAKING A SERVICE CALL	30
10. EXTERNAL APPEARANCE DIAGRAM	31

1. COMPONENTS

(1) Camera head (without lens, protection cap attached)	1
(2) Camera control unit	1
(3) Accessories	1
(a) Instruction manual	1
(b) Warranty card	1

2. SPECIFICATIONS

Power supply	DC12V \pm 10%
Power consumption	7.4W
Pick-up system	RGB, 3 CCD, Micro prism system
Image sensor	1/3 inch IT-CCD
Effective pixels	Horizontal: 768 pixels, Vertical: 494 pixels
Scanning system	2:1 interlace
Scan frequency	Horizontal: 15.734kHz, Vertical: 59.94Hz
Sync system	Internal/External (automatic switching)
Horizontal resolution	750 TV lines
Sensitivity	F8 (2000 lx, 3000K)
Minimum illumination	10 lx. (F2.2, Sensitivity +18 dB, 3000K)
SN ratio	62 dB standard
Lens mount	C mount (flange back: 17.526 mm in-air)
Ambient operating temperature	32 ~ 104°F (0 ~ 40°C)
Ambient humidity	Less than 90%
Weight	Camera head: Approx. 2.1 oz (60g), Camera control unit: Approx. 1.48 lbs (670g)
External dimension (except for protruded portions)	Camera head: 1.27" (W) x 1.57" (H) x 1.58" (D) (32.5 (W) x 40 (H) x 40.2 (D) mm) Camera control unit: 4.33" (W) x 1.57" (H) x 6.14" (D) (110 (W) x 40 (H) x 156 (D) mm)
Scene file (user memories)	A, B, C
White balance	ATW (Automatic tracing white balance), AWB (Automatic white balance), MANU (Manual)
Gain	AUTO (Automatic gain control), MANU (Manual), NORM (0 dB)
Output signal	VBS: 75 Ω unbalanced, BNC connector, NTSC standard Y/C: 75 Ω unbalanced, S terminal RGB or Y/PR/PB: 75 Ω unbalanced, D sub 9 pin connector VBS or Y/C: 75 Ω unbalanced, D sub 9 pin connector
External sync input	VBS/BB: 75 Ω unbalanced, Sync negative BNC connector SYNC 0.286V, Burst 0.286V HD or VD: 2 ~ 5V(p-p) Negative
Sync signal output	SYNC: 2.5 \pm 1V(p-p), 75 Ω unbalanced HD or VD: 5V V(p-p), Negative, Load impedance: More than 10 k Ω
1 pulse trigger	TRIGGER: L level: Less than 0.5V, H level: 4 ~ 5V, Positive
Index output:	INDEX: L level: Less than 0.5V, H level: 4 ~ 5V Negative, Load impedance: More than 10 k Ω

Remote interface:	Serial data interface (RS-232C standard)
Option (Optional parts)	EXC-T406 (Camera cable 21'10" (6.5m)) EXC-T403 (Camera cable 9' 9" (3m))

3. ITEMS CONTROLLED BY USING ON SCREEN DISPLAY

Item		Available selections	Preset value (Factory setting)	
Ectonic shutter	MODE	AUTO, MANU, SS, 1 PULSE	MANU	
	AUTO level	-99 ~ 00 ~ 99	00	
	AUTO peak (average)	00:10 ~ 05:05 ~ 10:00	05:05	
	AUTO response speed	01 ~ 05 ~ 10	05	
	AUTO area	PRESET A, PRESET B, PRESET C, PRESET D, USER (USER area is possible to set in 64 zones.)	PRESET A	
	MANU speed	OFF, 1/100s, 1/250s, 1/500s, 1/1000s, 1/2000s, 1/4000s, 1/10000s	OFF	
	Syncro. scan	FLD	001/525H ~ 260/525H, OFF, 001FRM ~ 255FRM	OFF
		FRM	001/525H ~ 260/525H, OFF, 001FRM ~ 256FRM	-
	1 PULSE	0.06ms ~ 16ms	16ms	
Storage mode	FLD, FRM	FLD		
AUTO maximum gain		00 dB ~ 18 dB	09dB	
AWB	Offset	-10 ~ 00 ~ 10	00	
	Area	PRESET A, PRESET B, PRESET C, PRESET D, USER (User area is possible to set in 64 zones.)	PRESET A	
Gamma correction switching		ON, OFF	ON	
Gamma correction level		-10 ~ 00 ~ 10	00	
Black gamma		LOW, NORM, HIGH	NORM	
Two-dimension low pass filter (2D LPF)		ON, OFF	OFF	
Detail gain		-5 (OFF) ~ 0 ~ 5	0	
Detail boost frequency		LOW, NORM, HIGH	NORM	
Master pedestal		-50 ~ 00 ~ 50	00	
Ext. sync.	H phase adjustment	-99 ~ 00 ~ 99	00	
	SC 0/180	0, 180	0	
	SC phase adjustment	-99 ~ 00 ~ 99	00	
OUTPUT	1	RGB, Y/PR/PB	RGB	
	2	VBS, Y/C	VBS	
Negative/Positive inversion		NEGA, POSI	POSI	
Detail signal output		ON, OFF	OFF	
Shading correction		ON, OFF	OFF	
G SYNC		ON, OFF	ON	

4. NAMES AND FUNCTIONS

Camera Head

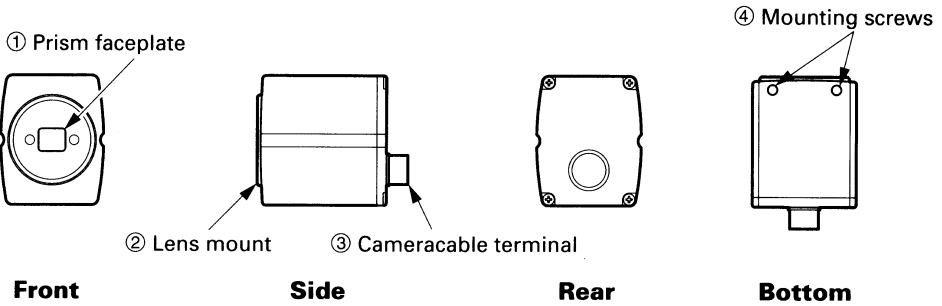

Camera Control Unit

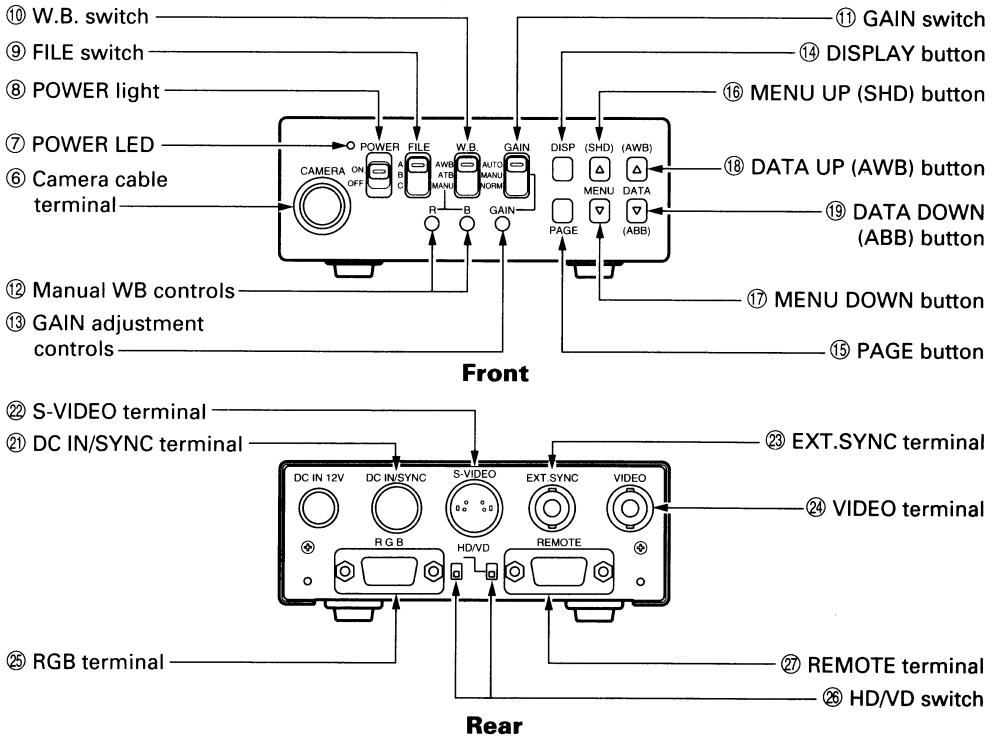

- ① Prism faceplate
The protection cap is attached on the lens mount portion. After removing the cap, mount the lens. Be careful not to scratch or touch the optical area.
- ② Lens mount
C mount lens is mounted.
- ③ Camera cable terminal
The camera cable is connected.
- ④ Mounting screws
Screw holes to fix the camera head mount. (M3 depth of camera section: 4mm)
- ⑤ None
- ⑥ Camera cable terminal
The camera cable is connected.
- ⑦ POWER LED
Lights when the power is turned on.
- ⑧ POWER switch
Turns on or off the power supply.
- ⑨ FILE switch
Switch the scene files. (A/B/C)
- ⑩ W.B. switch
Switch the white balance mode. (ATW/AWB/MANU)
- ⑪ GAIN switch
Switch the gain mode. (AUTO/MANU/NORM)
- ⑫ Manual WB controls
Adjust R and B gains when the white balance switch ⑩ is set to MANU.
- ⑬ GAIN adjustment controls
Adjust video signal gain when the gain switch ⑪ is set to MANU.
- ⑭ DISPLAY button
Used when switching the display.
- ⑮ PAGE button
Used when switching to the menu and when selecting the menus.
- ⑯ MENU UP (SHD) button
Select the function to be confirmed or changed on the menu. (Also used when performing the shading correction.)
- ⑰ MENU DOWN button
Select to confirm the function or to change the menu.
- ⑱ DATA UP (AWB) button
Changes the value of the function selected by the MENU (UP/DOWN) button. (Also used when using AWB.)
- ⑲ DATA DOWN (ABB) button
Changes the value of the function selected by the MENU (UP/DOWN) button. (Also used when using ABB.)
- ⑳ DC IN 12V terminal
Accept a DC power input (12V).
- ㉑ DC IN/SYNC terminal
When DC IN 12V terminal ㉑ is not used, accept DC12V input. HD and VD signals are input/output. (The input/output is switched by the HD/VD switch ㉒.) When 1 pulse operation is used, the trigger signal is input and the index signal is output.
- ㉒ S-VIDEO terminal
Outputs Y (luminance) and C (color) signals.
- ㉓ EXT. SYNC terminal
Used when the camera output signal is synchronized by the external signal. (BNC connector)
- ㉔ VIDEO terminal
VBS output. Connected to a monitor, VTR, etc. (BNC connector)
- ㉕ RGB terminal
Used as the connector terminal for Y/C or VBS output 2, or A, RGB or Y/P_R/P_B output, or SYNC output.
- ㉖ HD/VD switch
Switch input/output of HD, VD signals at DC IN/SYNC terminal ㉑.
Switch terminal resistor when HD and VD signals are input.
- ㉗ REMOTE terminal
Used when controlling functions of the camera by RS-232C.

5. CONNECTION

5.1 Standard Connection

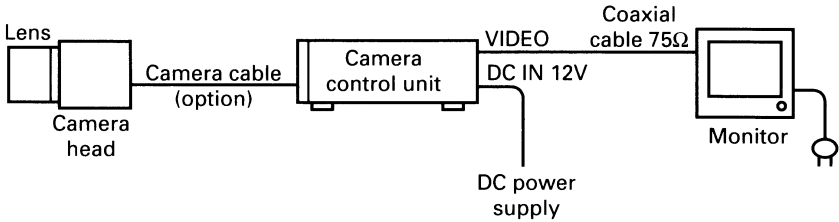

5.2 Cautions on Connection

- When connecting the camera cables, be sure to turn off the camera control unit and the other equipment connected.
- For DC power supply connecting to DC IN 12V terminal, use UL listed and/or CSA approved ungrounding type AC adaptor with the specifications described below.

Power supply voltage: DC12V \pm 10%
Current rating: More than 830mA, less than 2.5A
Ripple voltage: Less than 50mV(p-p)
Connector: HR10A-7P-4S by HIROSE electronics Co. Ltd.
Pins 1, 2: 12V
Pins 3, 4: GND

- We suggest to use a C mount lens for 3CCD camera.

When using other lens, the best camera performance of this camera may not be obtained.

(For example, low resolution may occur, focus may be lost through the range of a zoom lens, and flare ghost shading may occur.)

Furthermore, in order to avoid damaging the mounting portion of the camera head, use a lens which projection dimension from the mounting base is less than 0.157" (4 mm).

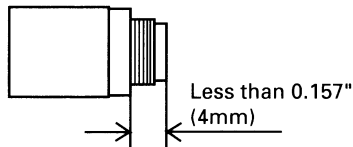

- If the screw on the camera connector portion of the camera cable looses, noise may appear on the screen. So be sure to tighten the connector fully.

5.3 Connection on Back Panel

Back panel view

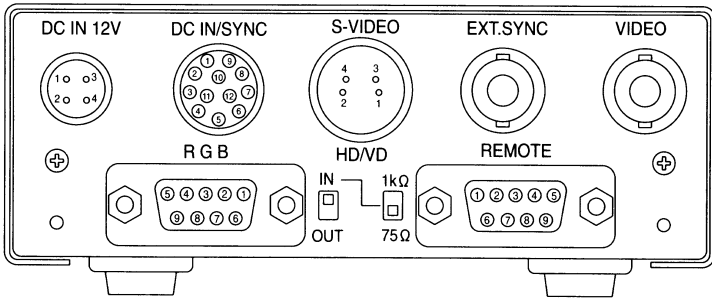

5.3A Connector Pin Assignments

DC IN 12V

1	+12V
2	+12V
3	GND
4	GND

DC IN/SYNC

1	GND
2	+12V
3	GND (for INDEX)
4	INDEX
5	GND (for HD)
6	HD (IN/OUT)
7	VD (IN/OUT)
8	GND (for TRIGGER)
9	TRIGGER
10	GND
11	+12V
12	GND (for VD)

S-VIDEO

1	GND
2	GND
3	Y
4	C

RGB

1	GND (for VBS, Y/C)
2	GND for R/G/B, Y/Pr/Pb)
3	R/Pr OUT
4	G/Y OUT
5	B/Pb OUT
6	VBS/Y OUT
7	SYNC OUT
8	GND (for SYNC)
9	-/C OUT

REMOTE

1	NC
2	TXD
3	RXD
4	DSR
5	GND
6	DTR
7	CTS
8	RTS
9	NC

* When using the REMOTE terminal, please consult with your dealer.

6. OPERATION

- ① Referring to the item "5. CONNECTION", connect each equipment correctly.
- ② Turn on the connected equipment and the camera.
- ③ When using the camera for the first time and when replacing the camera cable and the camera head, be sure to operate the ABB adjustment in advance, referring to the item "6.1 Automatic Black Balance".
- ④ Facing the lens to the object, operate the lens iris adjustment, focus adjustment, etc.
- ⑤ Referring to the item "6.2 White Balance", operate the adjustment.
- ⑥ Referring to the items "6.3 Scene File, 6.4 Gain, 7. MODE SETTING BY ON SCREEN DISPLAY", select the necessary items.

6.1 Automatic Black Balance

Black balance adjustment is necessary to get the correct black picture level.

- Close the lens iris.
- Disable the color bar pattern or the character display by pushing the [DISP] button, if necessary.
- Hold the [DATA DOWN] button for approx. 1 second.
- When the black balance adjustment operation starts, the character ABB blinks on the screen.
- When the black balance adjustment operation finishes, the character ABB ends blinking and the result appears for approx. 1 second.

6.2 White Balance

For the white balance adjustment for this camera, ATW (Automatic Trace White balance), AWB (Automatic White Balance) and MANU (manual white balance) adjustments are provided. Select the desired mode by the [W.B.] switch.

Display	Meaning
ABB OK	Automatic black balance adjustment finishes correctly.
ABB NG CLOSE LENS	Automatic black balance adjustment cannot be performed because the lens iris is open. Close the lens iris.
ABB NG	Automatic black balance adjustment cannot be performed. Operate the automatic black balance again.

	ATW (Automatic Trace White balance)	AWB (Automatic White Balance)	MANU (Manual White Balance)
Outline	Camera measures the object color temperature and adjust the white balance automatically.	Adjust white balance by displaying the white object inside the area set by AWB menu and pressing the [DATA UP] button.	Adjust the white balance manually using the white balance adjustment controls while shooting the white object.

	ATW (Automatic Trace White balance)	AWB (Automatic White Balance)	MANU (Manual White Balance)
Features	Traces variations of color temperature and adjusts the white balance automatically.	Measurement accuracy is higher than ATW. This mode is effective when shooting under less variations of color temperature.	Artificial white balance setting can be set. The manual adjustment is most effective under shooting condition with no color temperature variation.
Notes	If an illumination is low, white balance may not be corrected. When the shutter speed is in the 1 pulse or the long period exposure mode, ATW is not available.	When the shutter speed is of the 1 pulse mode, AWB is not available.	Adjustment is performed by confirming with a monitor or a vector scope.

① AWB

- Set [WB] switch to AWB.
- Disable the color bar pattern or the characters by pushing the [DISP] button, if necessary.
- Shoot a known white object entirely in the area set by the AWB menu (refer to the item "7.2 (3.2) (b) Changing AWB measurement light area".) and push [DATA UP] button for approx. 1 second.
- The character AWB blinks on the screen when the AWB starts.
- The character AWB ends blinking when the AWB finishes, and the result is displayed for approx. 1 second.

Display	Meaning
AWB OK	Automatic white balance adjustment finishes correctly.
AWB NG LEVEL NG	Automatic white balance adjustment cannot be performed because the video level is too high or too low. Set the video level properly.
AWB NG C. TEMP LOW	Automatic white balance adjustment cannot be performed because the color temperature is too low. Change the illumination or use a color temperature conversion filter.
AWB NG C. TEMP HIGH	Automatic white balance adjustment cannot be performed because the color temperature is too high. Change the illumination or use the color temperature conversion filter.
AWB NG NOT AVAILABLE	Automatic white balance adjustment cannot be performed because the shutter speed mode is 1 pulse mode.
AWB NG	Automatic white balance adjustment cannot be performed for other reasons. Such as no white area is included in an object, etc.

② MANU

- Set the [WB] switch to MANU.
- Shoot a known object, adjust the white balance using the white balance adjusting controls with a screwdriver, confirming with a monitor or a vector scope.

6.3 Scene File

Three scene files (A, B, C) are user memories for camera setup. These are selectable depending on shooting conditions. By switching [FILE] switch, the camera operation is changed immediately. (Refer to the item "7. MODE SETTING BY ON SCREEN DISPLAY").

6.4 Gain

When the picture image is dark even if the lens iris is open, change the gain (video gain) to get proper video level.

For the gain adjustment of the camera, AUTO (Automatic gain control), MANU (Manual), NORM (0 dB) modes are provided. Select by the [GAIN] switch.

① AUTO

- When the output is low, the gain is automatically adjusted to a suitable video level.
- The maximum value of the gain is 18 dB, possible to be set within 0 ~ 18 dB in 1 dB step. For the setting method, please refer to the item "7.2 Menus".
- Measurement light area is same as the automatic shutter. (please refer to the item 7.2 (1.1) Changing each setting in AUTO mode".)

② MANU

- Gain adjustment is performed by the GAIN adjusting control.
- The adjusting range is 0 dB to 18 dB.
- When confirming the gain value set, refer to the item "7.2 (2.2) MANU (manual) mode menu".

③ NORM

- Gain is fixed to 0 dB.

6.5 Shading Correction

Due to the lens used or the environmental condition, color shading may occur at the upper and lower side of the screen. In this case, the automatic shading correction can decrease the color shading.

- Turn the SHADING on. When it is off, the automatic shading correction cannot be performed. When changing the setting, refer to the item "7.2 (6.5) Changing shading".
- When the shutter speed mode is set to 1 PULSE or the long period exposure mode, the automatic shading correction cannot be performed.
- Disable the color bar and the characters by pushing the [DISP] button, if necessary.

- Push the [MENU UP] button for approx. 1 second.
- When the automatic shading correction operation starts, the character SHD blinks.
- When the automatic shading correction operation terminates, the character SHD ends blinking and the result is displayed for approx. 1 second.

Display	Meaning
SHD OK	Automatic shading correction operation terminates correctly.
SHD LIMIT	Automatic shading correction operation terminates. However, the most proper value cannot be selected in the correction value range. So the value is set to the most proper value within the correction range.
SHD NG LEVEL NG	Automatic shading correction cannot be performed because the video level is too high or too low. Set the video level properly.
SHD NG NOT AVAILABLE	Automatic shading correction operation cannot be performed because the shutter speed mode is the 1 pulse mode or the long period exposure mode.

The automatic shading correction is effective when the lens iris or zoom ratio is fixed. Use the camera with SHADING OFF for variable lens conditions.

7. MODE SETTING BY ON SCREEN DISPLAY

Various settings can be controlled on the camera by using the on screen menu displayed on the monitor. The contents once set are memorized in the scene files (A, B, C) selected, so if the power turns off, it is unnecessary to set again when using the camera next time. When the setting is performed, select the menu of the item to be set.

7.1 Using the Menus

When the power turns on, the normal screen showing only the video signal appears. Change the output to each screen (video signal output, color bar screen, Index menu, menus, and area menu) by using the [DISP], [PAGE], [MENU UP], and [MENU DOWN] buttons.

(A menu is selected when pushing the [PAGE] button after moving the "→" on the screen by the [MENU UP], [MENU DOWN] button while the Index menu is displayed.)

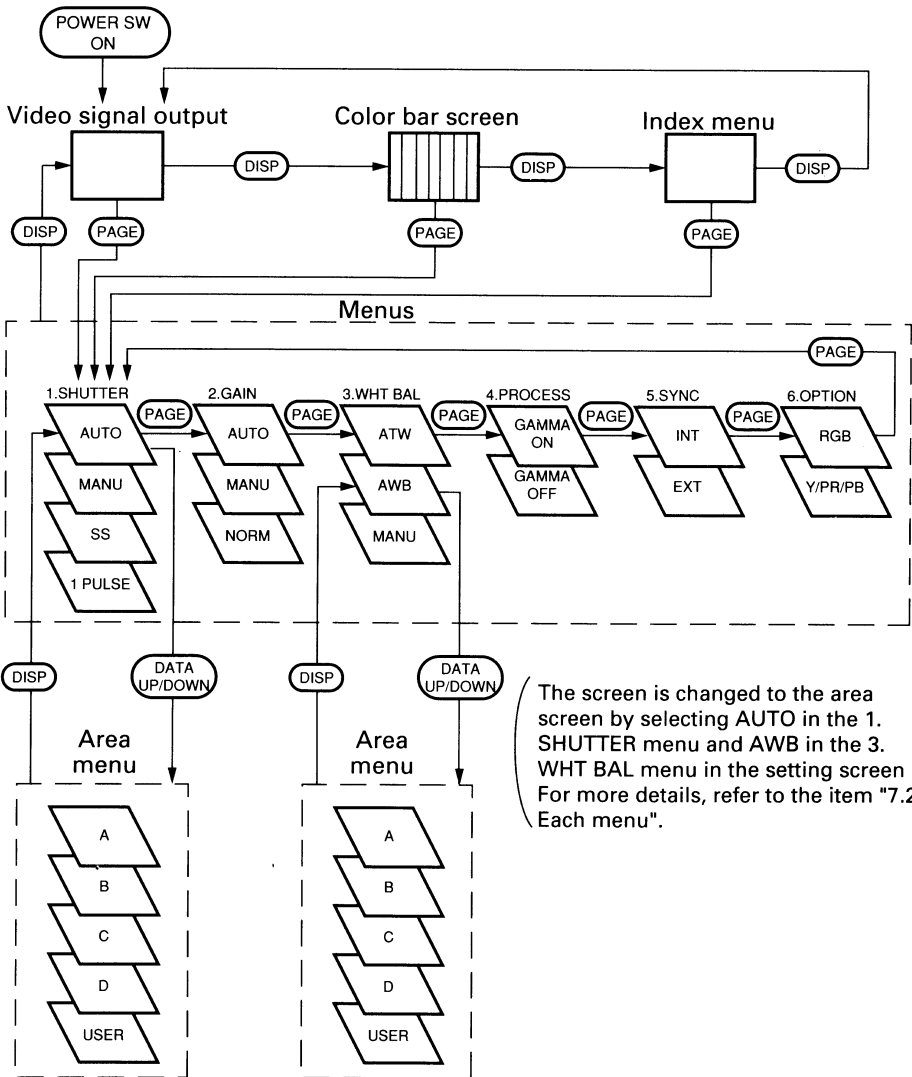

7.2 Menus

- Select the menu to change the setting by referring the item "7.1 Using the Menu".)
- When the [MENU UP], [MENU DOWN] buttons are pushed, the "→" on the screen moves up and down. Move the "→" to the item to change.

(1) SHUTTER (Electronic shutter)

The electronic shutter has four modes; AUTO, MANU, SS (Syncro. Scan), 1 PULSE.

Move the "→" to one of the modes and push the [DATA UP], [DATA DOWN], and select mode among AUTO, MANU, SS, 1 PULSE.

→AUTO↔MANU↔SS↔1PULSE←

AUTO: The exposure time is controlled automatically to obtain the video level set.

MANU: Possible to select the exposure time among eight kinds of speed; OFF (1/60s), 1/100s, 1/250s, 1/500s, 1/1000s, 1/2000s, 1/4000s, 1/10000s.

Note:

When setting a rapid shutter speed, sensitivity degrades according to the speed. When a discharging light such as fluorescent lamp, etc. is used for the illumination, the flicker may be large.

SS: Shutter speed can be set by the horizontal scanning time (1H) unit or by the frame unit.

1 PULSE: Outputs 1 field picture image by exposing the CCD immediately after the trigger pulse is fed from an external circuit.

(1.1) Changing each setting in AUTO mode

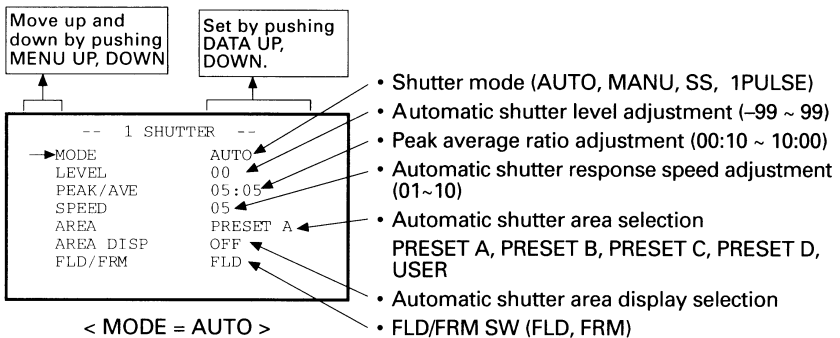

(a) Changing the video level in the automatic shutter mode.

- ① Set the "→" to LEVEL by pushing [MENU UP], [MENU DOWN] buttons.
- ② Set the video level by pushing [DATA UP], [DATA DOWN] buttons.

→ The value increases by pushing [DATA UP].

-99 ←----- 00 -----> 99

← The value decreases by pushing [DATA DOWN].

(b) Changing the automatic shutter detection (ratio between peak and average value)

- ① Set the “→” to PEAK/AVE by pushing [MENU UP], [MENU DOWN] buttons.
- ② Set the ratio between peak and average value by pushing [DATA UP], [DATA DOWN] buttons.

(Peak : Average value) → The peak value increases by pushing [DATA UP].

00:10 <-----> 05:05 <-----> 10:00

← The peak value decreases by pushing [DATA DOWN].

(c) Changing the automatic shutter response speed

- ① Set the “→” to SPEED by pushing [MENU UP], [MENU DOWN] buttons.
- ② Set the response speed by pushing [DATA UP], [DATA DOWN] buttons.

→ The response speed becomes quick by pushing [DATA UP].

01 <-----> 05 <-----> 10

← The response speed becomes slow by pushing [DATA DOWN].

(d) Changing the automatic shutter zone area

- ① Set the “→” to AREA by pushing [MENU UP], [MENU DOWN] buttons.
- ② Set the measurement light area by pushing [DATA UP], [DATA DOWN] buttons.

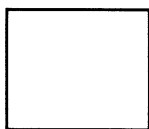
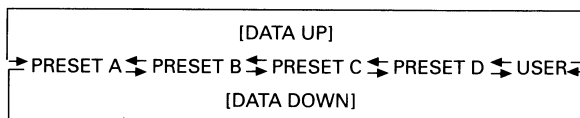

PRESET A

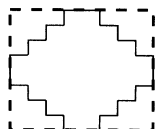

PRESET B

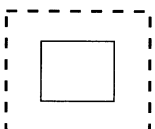

PRESET C

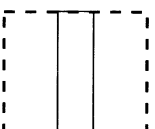

PRESET D

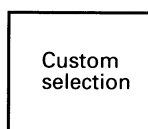

USER

(e) Confirming the contents of the measurement light area selected by the automatic shutter

- ① Set the “→” to AREA DISP by pushing [MENU UP], [MENU DOWN] buttons.
- ② Area screen appears by pushing [DATA UP], [DATA DOWN] buttons.

When AREA is set to USER, the setting can be changed on the area menu. When changing the area, refer to the item “7.2 (7) Setting USER area”.

- ③ Push the [DISP] button to return to the menu.

(f) Changing the CCD storage mode

- ① Set the “→” to FLD/FRM by pushing [MENU UP], [MENU DOWN] buttons.
- ② Select either FLD (field) or FRM (frame) by pushing [DATA UP], [DATA DOWN] buttons.

(1.2) Changing each setting in MANU mode

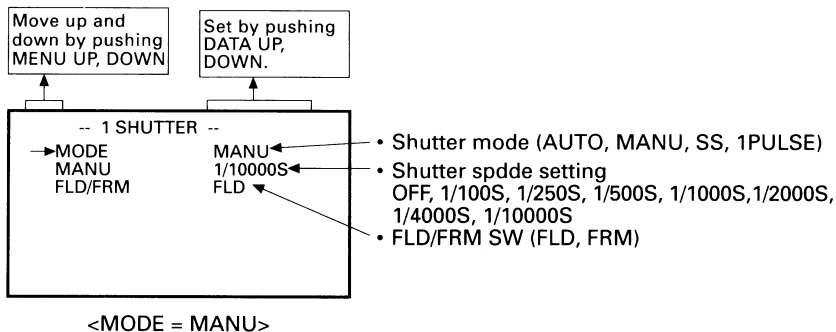

(a) Changing the shutter speed

- ① Set the "→" to MANU by pushing [MENU UP], [MENU DOWN] buttons.
- ② Set the shutter speed by pushing [DATA UP], [DATA DOWN] buttons.

→ [DATA UP]

OFF ↔ 1/100S ↔ 1/250S ↔ 1/500S ↔ 1/1000S ↔ 1/2000S ↔ 1/4000S ↔ 1/10000S

← [DATA DOWN]

(b) Changing CCD storage mode

- ① Set the "→" to FLD/FRM by pushing [MENU UP], [MENU DOWN] buttons.
- ② Select either FLD (field) or FRM (frame) by pushing [DATA UP], [DATA DOWN] buttons.

(1.3) Changing each setting in SS (syncro. scan) mode

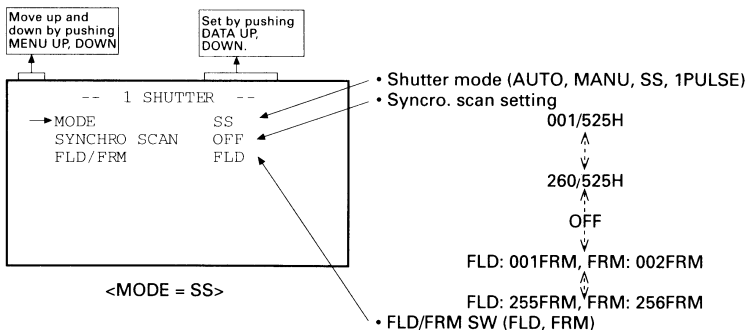

(a) Changing the shutter speed setting

- ① Set the "→" to SYNCHRO SCAN by pushing [MENU UP], [MENU DOWN] buttons.
- ② Select the shutter speed by pushing [DATA UP], [DATA DOWN] buttons.

→ [DATA UP]

001/525H ↔ 260/525H ↔ OFF ↔ 001FRM ↔ 255FRM at FLD
002FRM 256FRM at FRM

← [DATA DOWN]

Long time exposure

(b) Changing CCD storage mode

- ① Set the "→" to FLD/FRM by pushing [MENU UP], [MENU DOWN] buttons.
- ② Select either FLD (field) or FRM (frame) by pushing [DATA UP], [DATA DOWN] buttons.

(1.4) Changing each setting in 1 PULSE mode

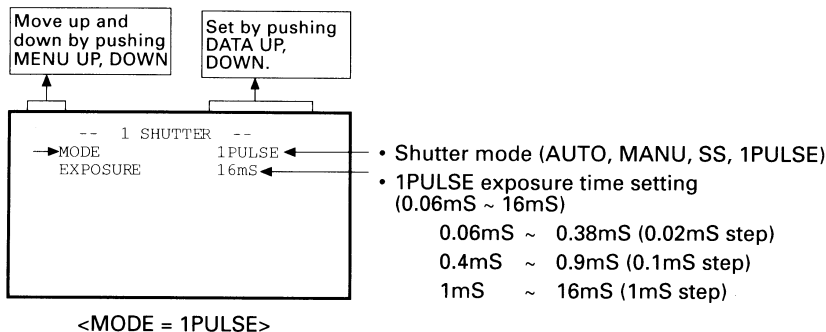

(a) Changing 1 PULSE exposure time setting

- ① Set the "→" to EXPOSURE by pushing [MENU UP], [MENU DOWN] buttons.
- ② Set the exposure time by pushing [DATA UP], [DATA DOWN] buttons.

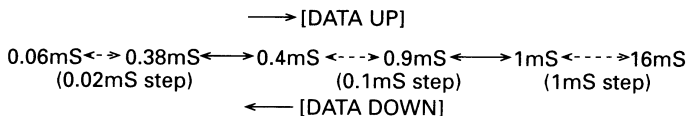

(2) GAIN (Video gain)

Display the [GAIN] switch position.

AUTO ↔ MANU ↔ NORM

(2.1) Changing the maximum gain in AUTO (Automatic gain control) mode

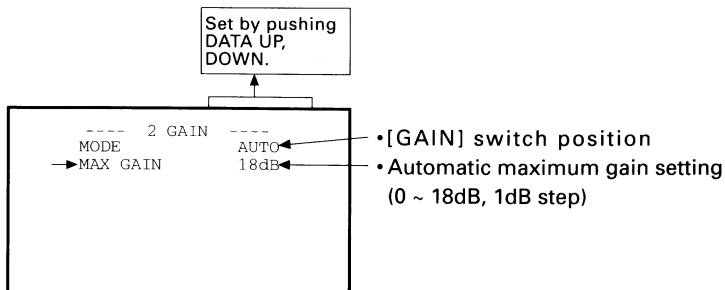

- ① Set by pushing [DATA UP], [DATA DOWN] buttons.

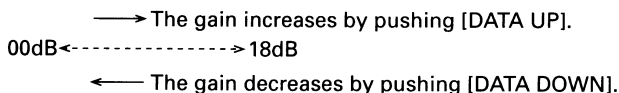

(2.2) MANU (manual) mode menu

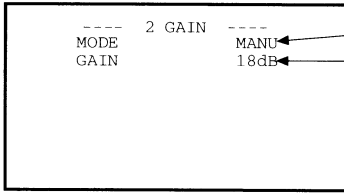

- [GAIN] switch position
- Manual gain display (0 ~ 18 dB, 1 dB step)

The GAIN set by the GAIN control is displayed . (Front panel)

(2.3) NORM (0 dB) mode menu

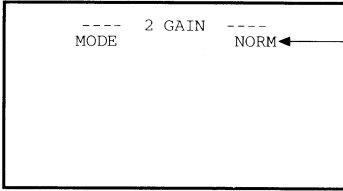

- [GAIN] switch position

(3) WHT BAL (white balance)

[W.B] (white balance) switch position is displayed.

ATW ↔ AWB ↔ MANU

(3.1) ATW (Automatic Trace White Balance) mode menu

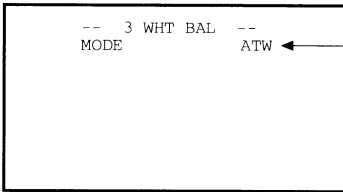

- [W.B] Switch position

(3.2) Changing the AWB (Automatic White Balance) mode setting

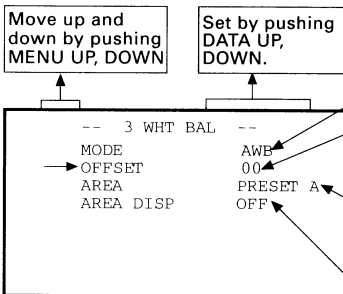

- [W.B] switch position
- AWB offset setting
+: Orange direction,
-: Cyan direction 10•10
- AWB area
PRESET A, PRESET B, PRESET C, PRESET D,
USER
- AWB area display

(a) Changing AWB offset (tint)

- ① Set the "→" to OFFSET by pushing [MENU UP], [MENU DOWN] buttons.
- ② Set the offset amount by pushing [DATA UP], [DATA DOWN] buttons.

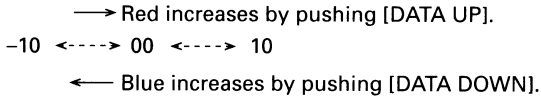

(b) Changing AWB zone area

- ① Set the "→" to AREA by pushing [MENU UP], [MENU DOWN] buttons.
- ② Select the area by pushing [DATA UP], [DATA DOWN] buttons.

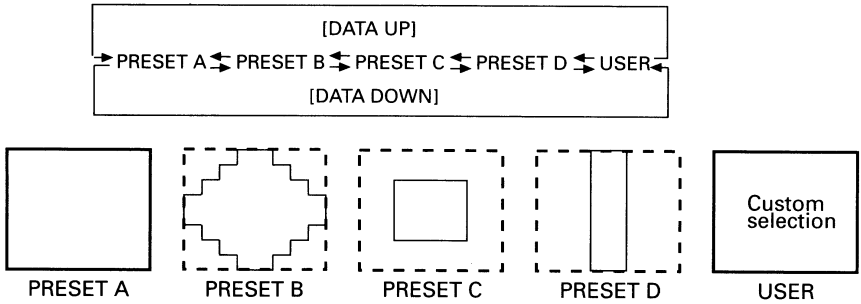

(c) Confirming the contents of the zone area selected by AWB

- ① Set the "→" to AREA DISP by pushing [MENU UP], [MENU DOWN] buttons.
- ② Set the screen to area display menu by pushing [DATA UP], [DATA DOWN] buttons.
When the AREA is set to USER, the AREA is set by the area display menu. When setting the area, refer to the item "7.2 (7) Setting the USER area".
- ③ Push the [DISP] button to return to the menu.

(3.3) MANU (manual) mode menu

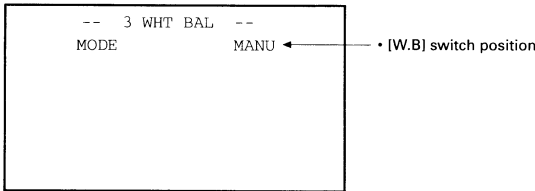

(4) PROCESS (Process)

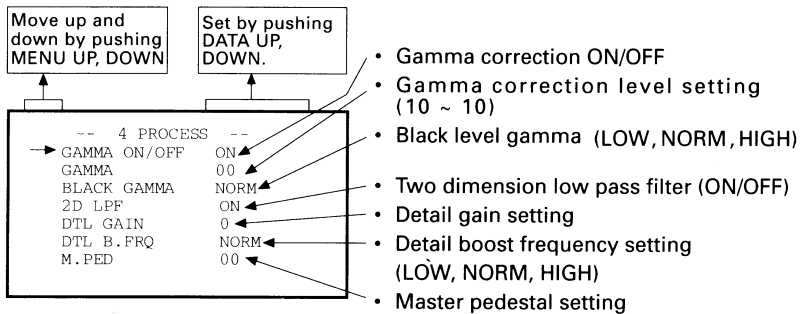

(4.1) Changing the gamma correction ON/OFF

- ① Set the "→" to GAMMA ON/OFF by pushing [MENU UP], [MENU DOWN] buttons.
- ② Select either ON or OFF by pushing [DATA UP], [DATA DOWN] buttons.

When ON is selected, menu will show the GAMMA and BLACK GAMMA selections.

When OFF is selected, GAMMA, BLACK GAMMA, and 2D LPF disappear. So the setting for GAMMA, BLACK GAMMA, and 2D LPF cannot be made. (2D LPF setting turns OFF.)

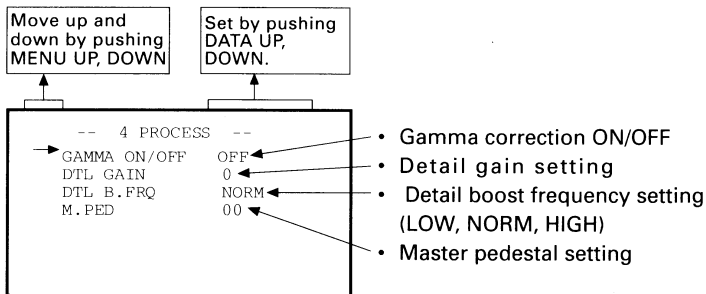

Menu when GAMMA OFF is selected.

(4.2) Changing gamma correction level

- ① Set the "→" to GAMMA by pushing [MENU UP], [MENU DOWN] buttons.
- ② Set the gamma correction level by pushing [DATA UP], [DATA DOWN] buttons.

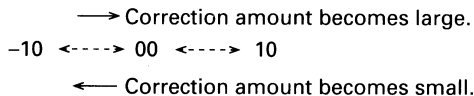

(When OFF is selected in GAMMA ON/OFF selection line, the display GAMMA turns off automatically. So the gamma correction level change cannot be changed.)

(4.3) Changing black gamma correction level

- ① Set the "→" to BLACK GAMMA by pushing [MENU UP], [MENU DOWN] buttons.
- ② Select black gamma correction by pushing [DATA UP], [DATA DOWN] buttons.

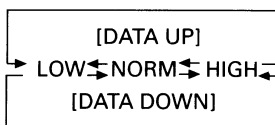

(When OFF is selected in GAMMA ON/OFF selection line, the display GAMMA turns off automatically. So the gamma correction level change cannot be changed.)

(4.4) Changing two-dimension low pass filter

- ① Set the "→" to 2D LPF by pushing [MENU UP], [MENU DOWN] buttons.
- ② Select either ON or OFF by pushing [DATA UP], [DATA DOWN] buttons.

When ON is selected, the cross color noise in VBS output is reduced.

Note:

Select OFF in step 2 described above when using signals other than the VBS output.

When OFF is selected in the GAMMA ON/OFF line or when DTL OUT ON is selected in the OPTION menu, the display 2D LPF turns off automatically. So 2D LPF change cannot be performed. (2D LPF is set to OFF.)

(4.5) Changing detail (outline) gain

- ① Set the "→" to DTL GAIN by pushing [MENU UP], [MENU DOWN] buttons.
- ② Set the detail gain by pushing [DATA UP], [DATA DOWN] buttons.

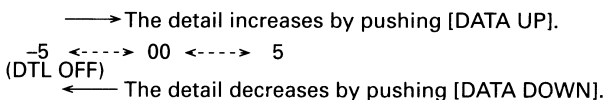

(When DTL OUT ON is selected in OPTION menu, the display DTL GAIN turns off automatically. So DTL GAIN change cannot be performed.)

(4.6) Changing detail boost frequency

- ① Set the "→" to DTL B.FREQ by pushing [MENU UP], [MENU DOWN] buttons.
- ② Set the detail boost frequency by pushing [DATA UP], [DATA DOWN] buttons.

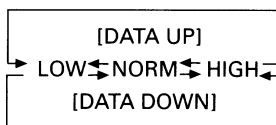

(4.7) Changing master pedestal

- ① Set the "→" to M. PED by pushing [MENU UP], [MENU DOWN] buttons.
- ② Set the master pedestal by pushing [DATA UP], [DATA DOWN] buttons.

→ M. PED rises by pushing [DATA UP].
 -50 <-----> 00 <-----> 50
 ← M. PED decreases by pushing [DATA DOWN].

(When DTL OUT ON is selected in OPTION menu, the display M. PED turns off automatically. So the M. PED change cannot be performed.)

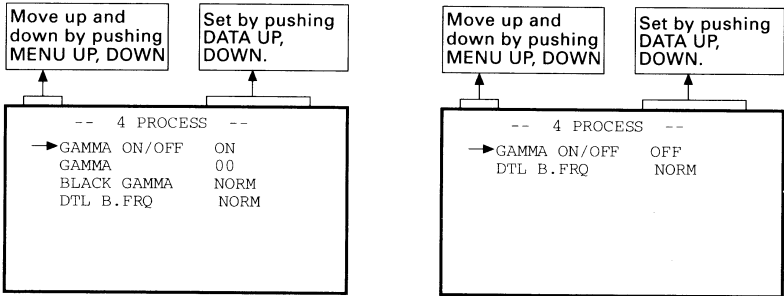

Menu when DTL OUT ON is selected in OPTION menu.

(5) SYNC (sync)

When an external sync signal is input, the display changes from INT (internal sync) to EXT (external sync) automatically.

INT ↔ EXT

(5.1) INT screen

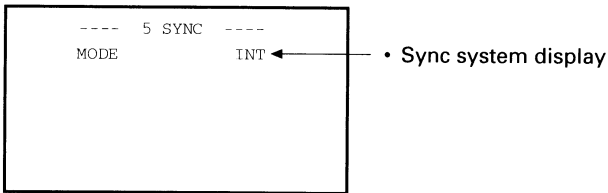

(5.2) Changing EXT setting

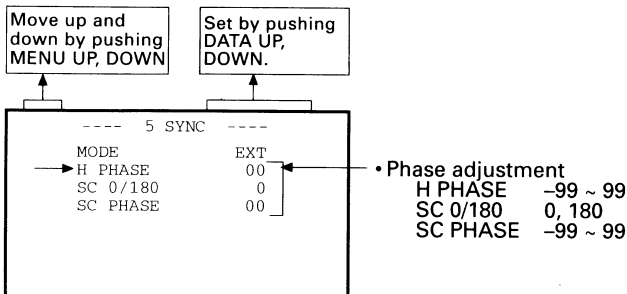

(a) Adjusting horizontal phase

- ① Set the "→" to H PHASE by pushing [MENU UP], [MENU DOWN] buttons.
- ② Adjust the horizontal phase by pushing [DATA UP], [DATA DOWN] buttons.

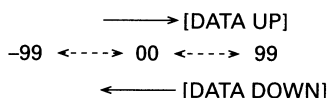

(b) Performing coarse adjustment of sub carrier phase

- ① Set the "→" to SC 0/180 by pushing [MENU UP], [MENU DOWN] buttons.
- ② Select either 0 or 180 by pushing [DATA UP], [DATA DOWN] buttons.

(c) Adjusting sub carrier phase

- ① Set the "→" to SC PHASE by pushing [MENU UP], [MENU DOWN] buttons.
- ② Adjust the sub carrier phase by pushing [DATA UP], [DATA DOWN] buttons.

(6) OPTION

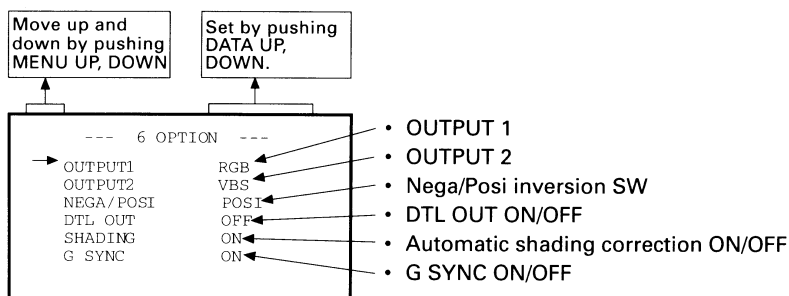

(6.1) Changing OUTPUT 1 output

- ① Set the "→" to OUTPUT 1 by pushing [MENU UP], [MENU DOWN] buttons.
- ② Select either RGB or Y/PR/PB by pushing [DATA UP], [DATA DOWN] buttons.

When Y/PR/PB is selected, the display G SYNC turns off automatically. So G SYNC change cannot be performed.

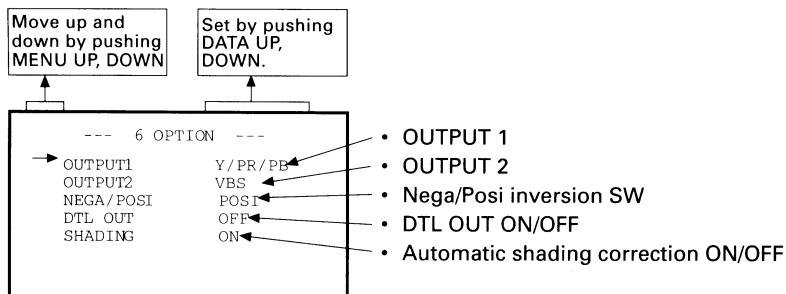

Menu when selecting Y/PR/PB

(6.2) Changing OUTPUT 2 output

- ① Set the "→" to OUTPUT 2 by pushing [MENU UP], [MENU DOWN] buttons.
- ② Select either VBS or Y/C by pushing [DATA UP], [DATA DOWN] buttons.

(6.3) Changing Negative/Positive inversion switch

- ① Set the "→" to NEGA/POS1 by pushing [MENU UP], [MENU DOWN] buttons.
- ② Select either NEGA (negative) or POS1 (positive) by pushing [DATA UP], [DATA DOWN] buttons.

(6.4) Changing detail signal output

- ① Set the "→" to DTL OUT by pushing [MENU UP], [MENU DOWN] buttons.
- ② Select either ON (detail signal only is output) or OFF (video signal) by pushing [DATA UP], [DATA DOWN] buttons.

(6.5) Changing shading

- ① Set the "→" to SHADING by pushing [MENU UP], [MENU DOWN] buttons.
- ② Select either ON or OFF by pushing [DATA UP], [DATA DOWN] buttons.

When ON is selected, the automatic shading correction can be performed by [MENU UP] button. When performing the automatic shading correction, refer to the item "6.5 Shading Correction". (Page 12)

(6.6) Changing G SYNC

- ① Set the "→" to G SYNC by pushing [MENU UP], [MENU DOWN] buttons.
- ② Select either ON or OFF by pushing [DATA UP], [DATA DOWN] buttons.

(When Y/P_R/P_B is selected, G SYNC disappears.)

(7) Setting USER area

- When USER is selected for the AREA of the automatic shutter or for AWB, the light measurement zones can be changed.
- The USER area is composed of 64 zones with 8 (vertical) x 8 (horizontal) areas, and each area can be set to ON/OFF.

- ① Set the output to area menu.

Set the output to the area menu by referring to the item "7.2 (1.1) (e) Confirming the contents of the measurement light area selected by automatic shutter" and "7.2 (3.2) (c) Confirming the contents of the zone area selected by AWB".

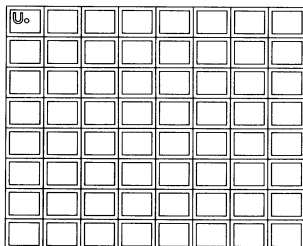

- ② Move the “o” to the zone to be appeared.

The display “o” moves up, down, left and right by pushing [MENU UP], [MENU DOWN], [DATA UP], [DATA DOWN] buttons.

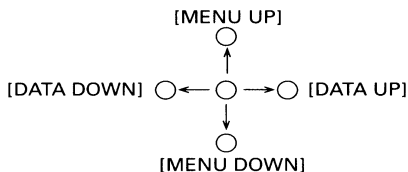

- ③ Select ON/OFF for the zone.

Select ON (effective) or OFF (ineffective) by pushing [PAGE] button.

When ON is selected, the display “□” appears on the screen and when OFF is selected, “□” turns off.

- ④ Push [DISP] button to return to the menu.

Note:

When OFF is selected for all 64 division areas, the automatic shutter function and AWB function are not performed correctly. So do not select OFF for all.

(8) Setting to factory setting status

The content set can be returned to the factory default status (preset status) for each file.

- ① Select a file to set to the factory default status by [FILE] switch.
- ② Disable the color bar display and the characters by pushing [DISP] button, if necessary.
- ③ Push [MENU DOWN] and [DATA DOWN] buttons simultaneously for approx. 1 second.
- ④ When the preset operation starts, the character PRESET blinks.
- ⑤ When the preset operation finishes, the character PRESET disappears.

7.3 External Sync

When using the camera with an external sync signal, input VBS (composite video signal) or BB (Black Burst) to “EXT. SYNC” terminal on the rear of the camera control unit, or input HD and VD to DC IN/SYNC terminal. When the external sync signal is input, the camera automatically switches its sync from the internal sync to the external sync. When inputting HD and VD, set the HD/VD switch on the rear of the camera control unit to IN.

(1) External sync signal input conditions

VBS, BB	:	SYNC section	0.286 ± 0.1V
(75Ω unbalanced)	:	Burst section	0.286 ± 0.1V
HD	:	2 ~ 5V(p-p) Negative	
VD	:	2 ~ 5V(p-p) Negative	

(2) External sync frequency range

For NTSC standard frequency: Within ± 50 ppm

(3) Using the camera with external sync signal

Adjust H (horizontal) phase and SC (sub carrier) phase if necessary to match the output of multiple cameras. When adjusting H (horizontal) phase and SC (sub carrier) phase, refer to the item "7.2 (5.2) Changing EXT setting".

(3.1) H (horizontal) phase adjustment

Observe the external sync signal and the video signal output waveform of the camera with a dual trace oscilloscope, and adjust H phase so that the H phase matches.

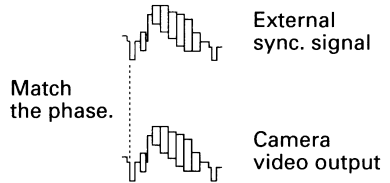

(3.2) SC (Sub carrier) phase adjustment

When using the camera with external sync, the sub carrier signal phase of the video output signal of the camera can be adjusted. Perform a coarse adjustment for 0° and 180° in SC 0/180 and then perform a fine adjustment in SC PHASE. Using a vector scope for the phase adjustment will provide more accuracy.

7.4 1 PULSE

Single exposure of the CCD is controlled when inputting the trigger pulse (TRIGGER) from DC IN/SYNC terminal and then output 1 field picture image.

- Trigger pulse level: Low Level : less than 0.5V, High level: 4 ~ 5V
 - Trigger signal fetch timing : Rising period
 - Trigger pulse width : More than $2 \mu\text{s}$
 - Trigger pulse interval : More than 50 μs
 - Trigger pulse input impedance : More than 15 k Ω
- (Time from trigger pulse input to start of electric charge: Within $2 \mu\text{s}$)

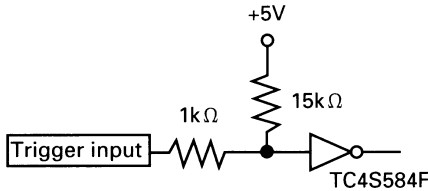

1 PULSE operation timing chart

- When the exposure period is within SYNC interval.

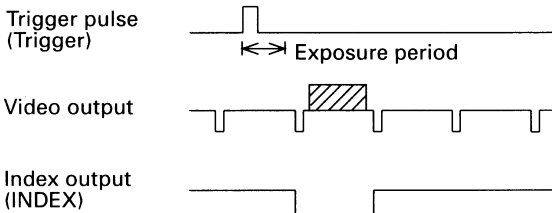

H: 4 ~ 5V
L: Less than 0.5V

- When the exposure period is over SYNC interval.

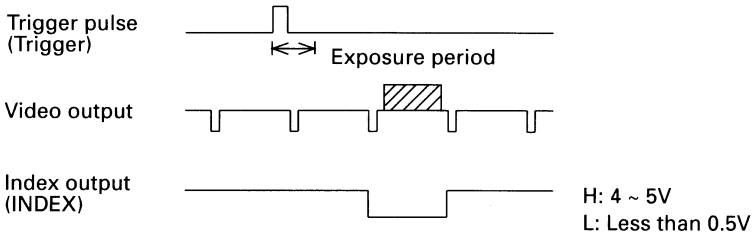

7.5 Syncro. Scan Operation

The shutter speed can be set by the horizontal scanning period (1H) or by the frame. Also, CCD integration mode can be set.

(1) Setting by 1H

260/525H ~ 001/525H stands for the setting by the 1H and the shutter speed can be set by the 1H (63.56 μ s). This function is used for flicker reduction when shooting non-synchronous sources such as VGA monitors.

(2) Setting by the frame

001FRM ~ 255FRM (at field storage) and 002FRM ~ 256FRM (at frame storage) stand for the setting (long period exposure) by the frame.

(a) Field storage period

The video signal stored during the frame period set is output as 1 field video image at a frame interval specified.

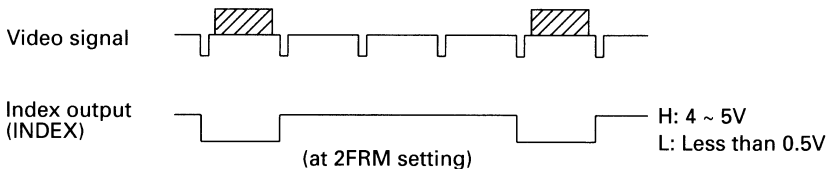

(b) Frame storage period

The video signal stored during the frame period set is output as 1 frame video image in a frame interval.

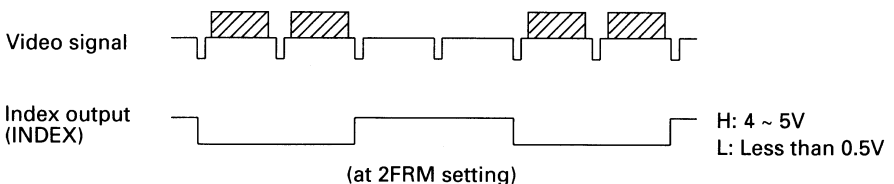

8. CAUTIONS ON USE AND INSTALLATION

● Carefully handle the units.

Do not drop or give a strong shock or vibration to the camera. This may cause problems. Treat the camera cables carefully to prevent cable problems such as cable break-down and loosened connections.

● Do not shoot intense light.

If there is an intense light at a location on the screen such as a spot light, a blooming and smearing may occur.

Do not aim the camera at the sun. If an intense light enters, vertical stripes may appear on the screen.

● Lens treatment.

Do not look at the sun through the lens.

● Handling of the camera head and protection cap.

Keep the camera head and the protection cap away from children. Children may put them into mouth or swallow them accidentally. The protection cap protects the image sensing plane when the lens is removed from the camera head, do not throw away.

● Do not touch internal parts.

Tampering with the internal parts may cause operation failure or injury.

● Operating ambient temperature and humidity.

Do not use the camera in places where temperature and humidity exceed the specifications. Picture quality will lower and internal parts may be damaged.

● Do not splash water.

Install the camera in a location free from water splash. If splashed, turn off the camera power switch and stop supplying power, then consult with your dealer.

● Install the camera in a location free from noise.

If the camera or the cables are located near power utility lines or a TV, etc. undesirable noise may appear on the screen. In such a case, try to change the location of the camera or the cable wiring.

● When not using the camera for a long-time.

Turn off the camera power switch and stop supplying power.

● Should you notice any trouble.

If an abnormality occurs such as no picture obtained, turn the camera power switch off and stop supplying power, then consult with the dealer. Using the camera without checking the cause of the trouble may lead to further damage or unexpected accident.

● When cleaning the camera

Always turn off the power and make a cleaning with a piece of dry cloth. If necessary, gently wipe with a cloth dampened with thinned detergent. Do not use benzine, alcohol, thinner, etc. If used, coating and printed letters may be discolored. When cleaning the lens, use a lens cleaning paper, etc.

9. BEFORE MAKING A SERVICE CALL

Symptom	Items to be checked
No picture	<ul style="list-style-type: none">• Is the power supplied correctly?• Is the lens iris adjusted correctly?• Are the cables connected correctly?• Is the shutter mode set correctly?
Poor color	<ul style="list-style-type: none">• Is the monitor (TV) adjusted correctly?• Is the white balance of the camera adjusted correctly? (in modes other than automatic trace)• Is the illumination dark?• Is the SC phase adjusted correctly? (External sync)
Noise appears	<ul style="list-style-type: none">• Is the camera connector of the camera cable loosened?

10. EXTERNAL APPEARANCE DIAGRAM

Unit: mm [inch]

